

KTA0800CP72

Edgewise and flat zed unit, Canalis KTA, aluminium, 800A, 3L+N+PER (Cu), high I_{cw}, made to measure, neutral N2, RAL9001

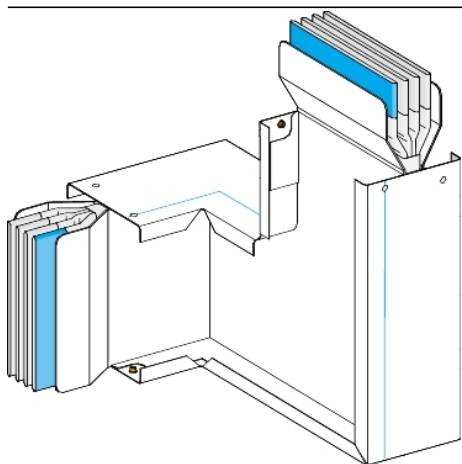

Main

Range	Canalis
Product name	KT
Product or component type	Multiple elbow
Busbar description	Standard
Device short name	KTA
Device application	Change direction
Material	Aluminium
[I _e] rated operational current	800 A at 35 °C
Polarity	3L + N + PER
Direction change type	Direction 1: flat to right Direction 2: edgewise to upward
Operating angle	90 °
Earth conductor	Reinforced
Short-circuit level	Reinforced version
Provided equipment	Trunking unit Jointing unit

Complementary

Housing material	Polyester film
Contacts material	Copper
[U _e] rated operational voltage	1000 V
Network frequency	50/60 Hz
[U _i] rated insulation voltage	1000 V
[I _{cw}] rated short-time withstand current	35 kA
[I _{pk}] rated peak withstand current	73 kA
Radiated magnetic field	0.4 μT
Thermal stress limit	1225000 kA ² .s
THDI	0...15 % 800 A 15...33 % 1000 A 33...100 % 1250 A
Maximum voltage drop	<0.0083 V with power factor = 1 at 50 Hz with 1A for 100 m long <0.0081 V with power factor = 0.9 at 50 Hz with 1A for 100 m long <0.0076 V with power factor = 0.8 at 50 Hz with 1A for 100 m long <0.0069 V with power factor = 0.7 at 50 Hz with 1A for 100 m long
Neutral position	Left
Standards	IEC 61439-1 IEC 61439-6
Dimension type	Made to measure
Width	140 mm
Height	Direction 2: 195...574 mm
Colour	White (RAL 9001)
Length	Direction 1: 300 mm Direction 3: 275 mm
Linear load	15 kg/m

The information provided in this documentation contains general descriptions and/or technical characteristics of the performance of the products contained herein. This documentation is not intended as a substitute for and is not to be used for determining suitability or reliability of these products for specific user applications. It is the duty of any such user or integrator to perform the appropriate and complete risk analysis, evaluation and testing of the products with respect to the relevant specific application or use thereof. Neither Schneider Electric Industries SAS nor any of its affiliates or subsidiaries shall be responsible or liable for misuse of the information contained herein.

Environment

IP degree of protection	IP55 conforming to IEC 60529
IK degree of protection	IK08 conforming to IEC 62262
Derating factor	0...35 °C (100 % of In) 35...40 °C (97 % of In) 40...45 °C (93 % of In) 45...50 °C (90 % of In) 50...55 °C (86 % of In)

Packing Units

Unit Type of Package 1	PCE
Number of Units in Package 1	1
Package 1 Height	34.8 cm
Package 1 Width	70.5 cm
Package 1 Length	31.7 cm
Package 1 Weight	15.7 kg