



Main

Range of product	Zelio Logic
Product or component type	Analogue I/O extension module

Complementary

Analogue input number	2
Analogue input type	Common mode
Analogue input range	0...10 V 0...20 mA -25...125 °C
Temperature probe type	Pt 100, 3-wire conforming to IEC 751
Maximum permissible voltage	30 V for analogue input circuit
[Imp] maximum permanent current	30 mA for analogue input circuit
Analogue input resolution	10 bits on the input range
Input impedance	18 kOhm, input range: 0...10 V for analogue input circuit 247 Ohm, input range: 0...20 mA for analogue input circuit
Analogue output number	2
Analogue output range	0...10 V
Analogue output resolution	10 bits on the output range
Load type	Resistive load for analogue output
Maximum load current	10 mA for analogue output
Short-circuit protection	With analogue output
LSB value	0.15 °C, - 25...125 °C for analogue input circuit 20 µA, 0...20 mA for analogue input circuit 9.8 mV, 0...10 V for analogue input circuit 9.8 mV, 0...10 V for analogue output
Conversion time	Smart relay cycle time for analogue input circuit Smart relay cycle time for analogue output
Conversion error	+/- 1 % of the full scale value, input range: 0...10 V (25 °C) for analogue output +/- 1 % of the full scale value, input range: 0...10 V (55 °C) for analogue output +/- 1 %, input range: 0...10 V (25 °C) for analogue input circuit +/- 1 %, input range: 0...10 V (55 °C) for analogue input circuit +/- 1 %, input range: 0...20 mA (25 °C) for analogue input circuit +/- 1 %, input range: 0...20 mA (55 °C) for analogue input circuit +/- 1.5 °C, input range: - 25...125 °C (25 °C) for analogue input circuit +/- 1.5 °C, input range: - 25...125 °C (55 °C) for analogue input circuit
Repeat accuracy	< +/- 0.3 °C, input range: - 25...125 °C at 25 °C for analogue input circuit <= +/- 1 %, input range: 0...10 V at 25 °C for analogue input circuit <= +/- 1 %, input range: 0...10 V at 55 °C for analogue output <= +/- 1 %, input range: 0...20 mA at 25 °C for analogue input circuit
Operating distance	10 m with screened cable for analogue input circuit 10 m with screened cable for analogue output
Reverse polarity protection	Analogue input circuit: with

The information provided in this documentation contains general descriptions and/or technical characteristics of the performance of the products contained herein. This documentation is not intended as a substitute for and is not to be used for determining suitability or reliability of these products for specific user applications. It is the duty of any such user or integrator to perform the appropriate and complete risk analysis, evaluation and testing of the products with respect to the relevant specific application or use thereof. Neither Schneider Electric Industries SAS nor any of its affiliates or subsidiaries shall be responsible or liable for misuse of the information contained herein.

Connections - terminals	Screw terminals, 1 x 0.25...1 x 2.5 mm ² (AWG 24...AWG 14) semi-solid Screw terminals, 1 x 0.25...1 x 2.5 mm ² (AWG 24...AWG 14) solid Screw terminals, 2 x 0.25...2 x 1.5 mm ² (AWG 23...AWG 16) solid Screw terminals, 1 x 0.25...1 x 2.5 mm ² (AWG 24...AWG 14) flexible with cable end Screw terminals, 2 x 0.25...2 x 0.75 mm ² (AWG 24...AWG 18) flexible with cable end
Tightening torque	0.5 N.m
Net weight	0.11 kg



Environment

Product certifications	GOST UL C-Tick CSA
Standards	EN/IEC 61000-4-12 EN/IEC 61000-4-5 EN/IEC 61000-4-3 EN/IEC 61000-4-4 level 3 EN/IEC 61000-4-6 level 3 EN/IEC 61000-4-2 level 3 EN/IEC 60068-2-6 Fc EN/IEC 61000-4-11 EN/IEC 60068-2-27 Ea
IP degree of protection	IP20 (terminal block) conforming to IEC 60529 IP40 (front panel) conforming to IEC 60529
Environmental characteristic	EMC directive conforming to EN/IEC 61000-6-2 EMC directive conforming to EN/IEC 61000-6-3 EMC directive conforming to EN/IEC 61000-6-4 EMC directive conforming to EN/IEC 61131-2 zone B Low voltage directive conforming to EN/IEC 61131-2
Disturbance radiated/conducted	Class B conforming to EN 55022-11 group 1
Pollution degree	2 conforming to EN/IEC 61131-2
Ambient air temperature for operation	-20...40 °C conforming to IEC 60068-2-1 and IEC 60068-2-2 -20...55 °C conforming to IEC 60068-2-1 and IEC 60068-2-2
Ambient air temperature for storage	-40...70 °C
Operating altitude	2000 m
Maximum altitude transport	3048 m
Relative humidity	95 % without condensation or dripping water

Packing Units

Unit Type of Package 1	PCE
Number of Units in Package 1	1
Package 1 Weight	107 g
Package 1 Height	6.1 cm
Package 1 width	6.5 cm
Package 1 Length	11 cm
Unit Type of Package 2	S03
Number of Units in Package 2	48
Package 2 Weight	5.585 kg
Package 2 Height	30 cm
Package 2 width	30 cm
Package 2 Length	40 cm

Offer Sustainability

Sustainable offer status	Green Premium product
REACH Regulation	 REACH Declaration
EU RoHS Directive	Pro-active compliance (Product out of EU RoHS legal scope)  EU RoHS Declaration
Mercury free	Yes
RoHS exemption information	 Yes

China RoHS Regulation	China RoHS Declaration
Environmental Disclosure	Product Environmental Profile
Circularity Profile	End Of Life Information
WEEE	The product must be disposed on European Union markets following specific waste collection and never end up in rubbish bins
PVC free	Yes

Contractual warranty

Warranty	18 months
----------	-----------

Analog I/O Extension Modules

Mounting on 35 mm/1.38 in. DIN Rail

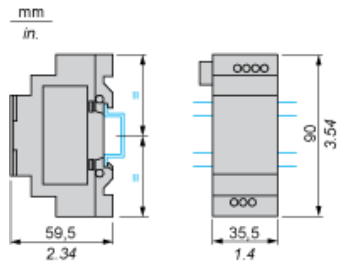

Screw Fixing (Retractable Lugs)

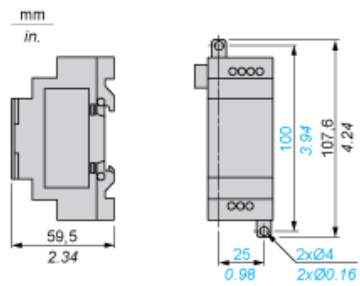

Connection of Smart Relays on DC Supply, with Analog I/O Extension Module

Connection Alternatives

0 - 10 V	0 - 20 mA	Pt100
2	0	0
1	1	0
0	2	0
1	0	1
0	1	1

Application Example with 1 x 0 - 10 V Input and 1 x Pt100 Input

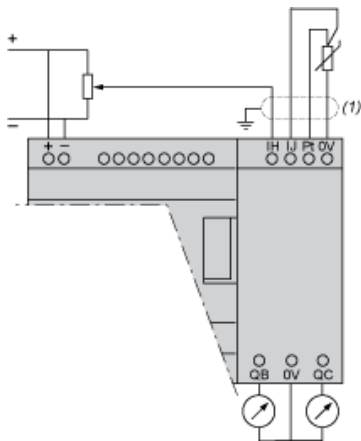

(1) Screened cables, maximum length 10 m/32.80 ft.

Application Example with 1 x 0 - 20 mA Input and 1 x 0 - 10 V Input

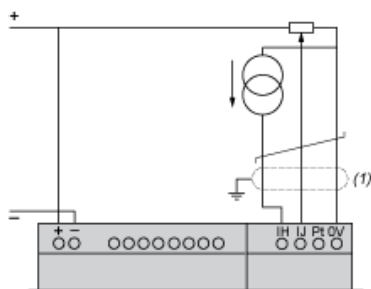

(1) Screened cables, maximum length 10 m/32.80 ft.

Compact and Modular Smart Relays

Electrical Durability of Relay Outputs

(in millions of operating cycles, conforming to IEC/EN 60947-5-1)

DC-12 (1)

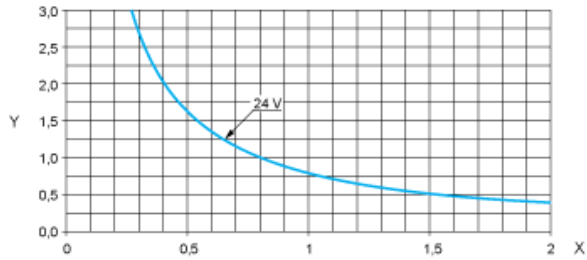

X: Current (A)

Y: Millions of operating cycles

(1) DC-12: control of resistive loads and of solid state loads isolated by opto-coupler, $L/R \leq 1$ ms.

DC-13 (1)

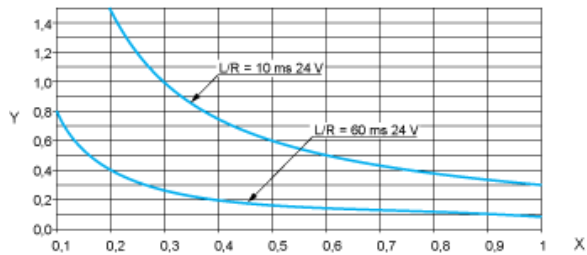

X: Current (A)

Y: Millions of operating cycles

(1) DC-13: switching electromagnets, $L/R \leq 2 \times (U_e \times I_e)$ in ms, U_e : rated operational voltage, I_e : rated operational current (with a protection diode on the load, DC-12 curves must be used with a coefficient of 0.9 applied to the number in millions of operating cycles).