

GV4L80S

Motor circuit breaker, TeSys GV4, 3P, 80 A, Icu 100 kA, magnetic, EverLink terminals



Main

| | |
|---------------------------------------|--|
| Range | TeSys |
| Product name | TeSys GV4 |
| Product or component type | Circuit breaker |
| Device short name | GV4L |
| Device application | Motor protection |
| Poles description | 3P |
| Utilisation category | Category A |
| Trip unit technology | Magnetic Electronic |
| Protection type | Short-circuit |
| [In] rated current | 80 A |
| Breaking capacity | Icu 120 kA at 220...240 V AC 50/60 Hz conforming to IEC 60947-2 Icu 100 kA at 380...415 V AC 50/60 Hz conforming to IEC 60947-2 Icu 70 kA at 440 V AC 50/60 Hz conforming to IEC 60947-2 Icu 30 kA at 500 V AC 50/60 Hz conforming to IEC 60947-2 Icu 18 kA at 525 V AC 50/60 Hz conforming to IEC 60947-2 Icu 10 kA at 660...690 V AC 50/60 Hz conforming to IEC 60947-2 |
| [Ics] rated service breaking capacity | 120 KA at 220...240 V AC 50/60 Hz conforming to IEC 60947-2 100 KA at 380...415 V AC 50/60 Hz conforming to IEC 60947-2 70 KA at 440 V AC 50/60 Hz conforming to IEC 60947-2 30 KA at 500 V AC 50/60 Hz conforming to IEC 60947-2 18 KA at 525 V AC 50/60 Hz conforming to IEC 60947-2 2.5 kA at 660...690 V AC 50/60 Hz conforming to IEC 60947-2 |
| Magnetic setting range | 480...1120 A |
| Control type | Rotary handle |

Complementary

| | |
|--|--|
| [Ue] rated operational voltage | 690 V AC 50/60 Hz conforming to IEC 60947-2 |
| Motor power kW | 37 KW at 400...415 V AC 50/60 Hz 45 KW at 500 V AC 50/60 Hz 55 KW at 500 V AC 50/60 Hz 22 KW at 400...415 V AC 50/60 Hz 30 KW at 500 V AC 50/60 Hz 37 KW at 660...690 V AC 50/60 Hz 45 KW at 660...690 V AC 50/60 Hz 55 KW at 660...690 V AC 50/60 Hz 30 KW at 400...415 V AC 50/60 Hz 37 kW at 500 V AC 50/60 Hz |
| [Uimp] rated impulse withstand voltage | IEC 60947-2 8 kV |
| [Ui] rated insulation voltage | 800 V conforming to IEC 60947-2 |
| Mounting mode | By screws By clips |

The information provided in this documentation contains general descriptions and/or technical characteristics of the performance of the products contained herein. This documentation is not intended as a substitute for and is not to be used for determining suitability or reliability of these products for specific user applications. It is the duty of any such user or integrator to perform the appropriate and complete risk analysis, evaluation and testing of the products with respect to the relevant specific application or use thereof. Neither Schneider Electric Industries SAS nor any of its affiliates or subsidiaries shall be responsible or liable for misuse of the information contained herein.

| | |
|--------------------------------------|--|
| Mounting support | 35 mm symmetrical DIN rail Plate 75 mm symmetrical DIN rail |
| Suitability for isolation | Yes conforming to IEC 60947-1 |
| Mechanical durability | 40000 cycles |
| Electrical durability | 14000 Cycles for AC-3 at 440 V In/2 7000 cycles for AC-3 at 440 V In |
| Local signalling | Green indicator for presence of auxiliary contacts |
| Number of slots | 1 slot(s) for alarm switch for fault signalling contact, plug-in 1 slot(s) for voltage release for electrical remote tripping, plug-in 1 slot(s) for auxiliary switch for open/close contact, plug-in |
| Toggle padlocking (with accessories) | Padlock in OFF or ON position |
| Connection pitch | 27 mm |
| Connections - terminals | Top 1 EverLink BTR screw connectors wire size 1.5...70 mm ² , solid Top 1 EverLink BTR screw connectors wire size 1.5...50 mm ² , flexible Bottom 1 EverLink BTR screw connectors wire size 2.5...95 mm ² , solid Bottom 1 EverLink BTR screw connectors wire size 2.5...70 mm ² , flexible |
| Tightening torque | 9 N.M for 16...95 mm ² 5 N.m for 1.5...10 mm ² |
| Wire stripping length | 20 mm |
| Quality labels | CE |
| Standards | EN/IEC 60947-2 EN/IEC 60947-4-1 |
| Height | 155 mm |
| Width | 81 mm |
| Depth | 165 mm |
| Net weight | 1.65 kg |
| Colour | Grey (RAL 7016) |

Environment

| | |
|---------------------------------------|--|
| Product certifications | IEC CCC EAC EU-RO MR |
| Tropicalisation | 2 conforming to IEC 68-2 |
| IP degree of protection | IP40 front face conforming to IEC 60529 |
| IK degree of protection | IK07 conforming to IEC 62262 |
| Pollution degree | 3 conforming to IEC 60947-1 |
| Mechanical robustness | Vibrations: +/- 1 mm 2...13.2 Hz conforming to IEC 60068-2-6 Vibrations: 0.7 gn 13.2...100 Hz conforming to IEC 60068-2-6 Shocks: 15 gn 11 ms conforming to IEC 60068-2-27 |
| Ambient air temperature for operation | -25...70 °C |
| Ambient air temperature for storage | -50...85 °C |
| Operating altitude | 0...2000 m without derating 2000...5000 m with derating |

Packing Units

| | |
|------------------|-----------|
| Package 1 Weight | 1.868 kg |
| Package 1 Height | 21.000 cm |
| Package 1 width | 10.000 cm |
| Package 1 Length | 22.000 cm |

Offer Sustainability

| | |
|----------------------------|---|
| Sustainable offer status | Green Premium product |
| REACH Regulation |  REACH Declaration |
| EU RoHS Directive | Compliant  EU RoHS Declaration |
| Mercury free | Yes |
| RoHS exemption information |  Yes |

| | |
|-----------------------------|---|
| China RoHS Regulation | China RoHS Declaration |
| Environmental Disclosure | Product Environmental Profile |
| Circularity Profile | End Of Life Information |
| WEEE | The product must be disposed on European Union markets following specific waste collection and never end up in rubbish bins |
| PVC free | Yes |
| Halogen content performance | Halogen free plastic parts product |
| Contractual warranty | |
| Warranty | 18 months |

Tripping Curves for GV4L and GV4LE Combined with Thermal Overload Relay LRD or LR9

Average Operating Times at 20 °C Related to Multiples of the Setting Current

GV4L02 and GV4LE02 to 12 with LRD05 to LRD14, GV4L80 and GV4LE80 with LRD3363

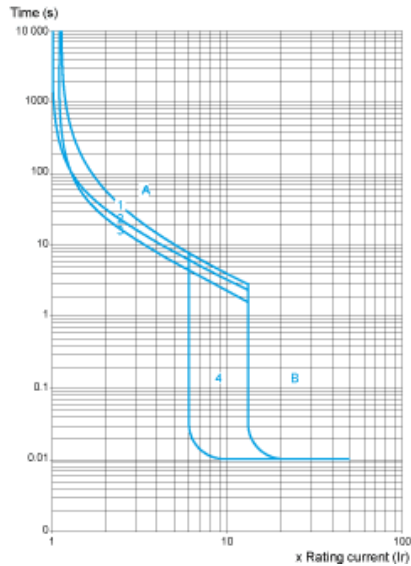

- 1 3 poles from cold state
- 2 2 poles from cold state
- 3 3 poles from hot state
- 4 6...14 Ir
- A Thermal overload relay protection zone
- B GV4L protection zone

GV4L25 and GV4LE25 with LRD 318, LRD325 GV4L50 AND GV4LE50 with LRD 332, LRD 340, LRD 350

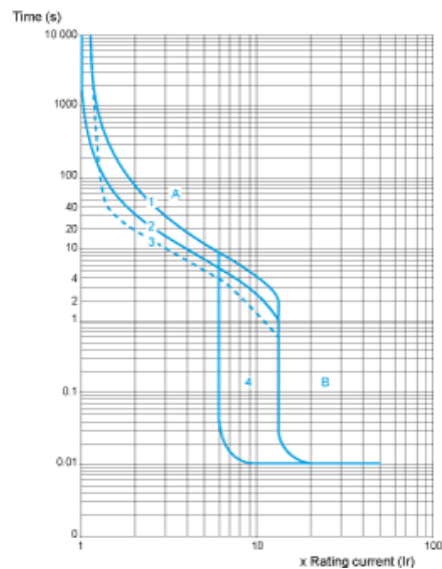

- 1 3 poles from cold state
- 2 2 poles from cold state
- 3 3 poles from hot state
- 4 6...14 Ir
- A Thermal overload relay protection zone
- B GV4L protection zone

GV4L115 and GV4LE115 with Class 10 LR9F5367, LR9D5369 and Class 20 LR9D5567, LR9F5569

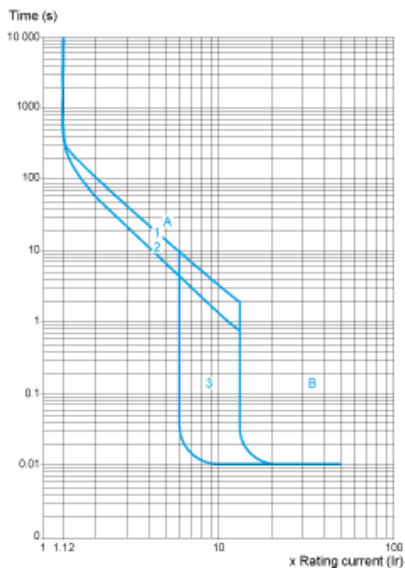

- 1 Cold state curve
- 2 Hot state curve
- 3 6...14 Ir

Current Limitation on Short-Circuit for GV4L, GV4LE (3-Phase 400/415 V)

Dynamic Stress

$I_{peak} = f(\text{prospective } I_{sc}) \text{ at } 1.05 U_e = 435 \text{ V}$

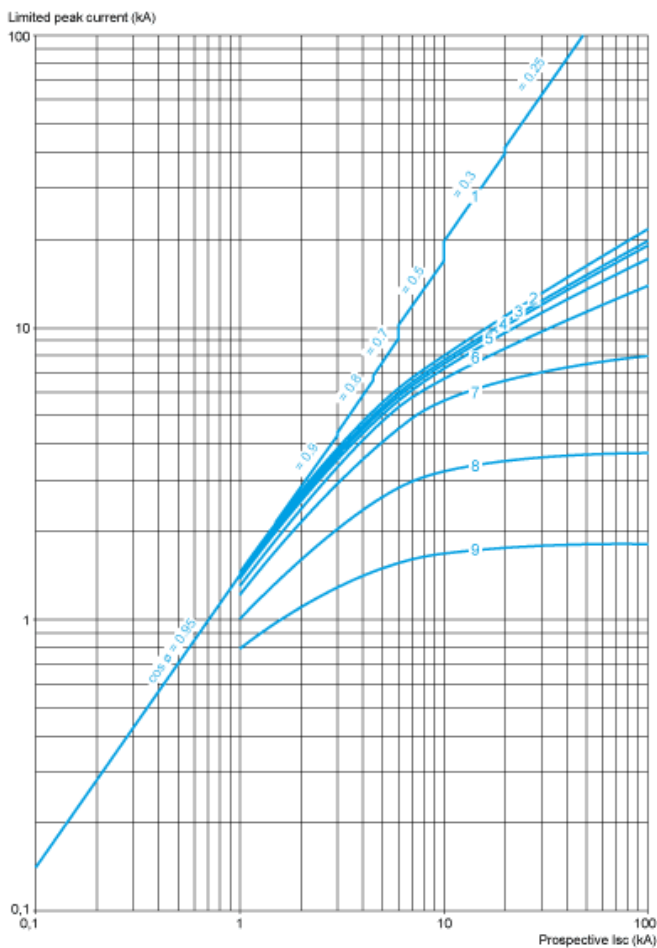

- 1 Maximum peak current
- 2 GV4L115
- 3 GV4L80
- 4 GV4L50
- 5 GV4L25
- 6 GV4L12
- 7 GV4L07
- 8 GV4L03
- 9 GV4L02

Current Limitation on Short-Circuit for GV4L, GV4LE + Thermal Overload Relay LRD or LR9 (3-Phase 400/415 V)

Dynamic Stress

$I_{peak} = f(\text{prospective } I_{sc}) \text{ at } 1.05 U_e = 435 \text{ V}$

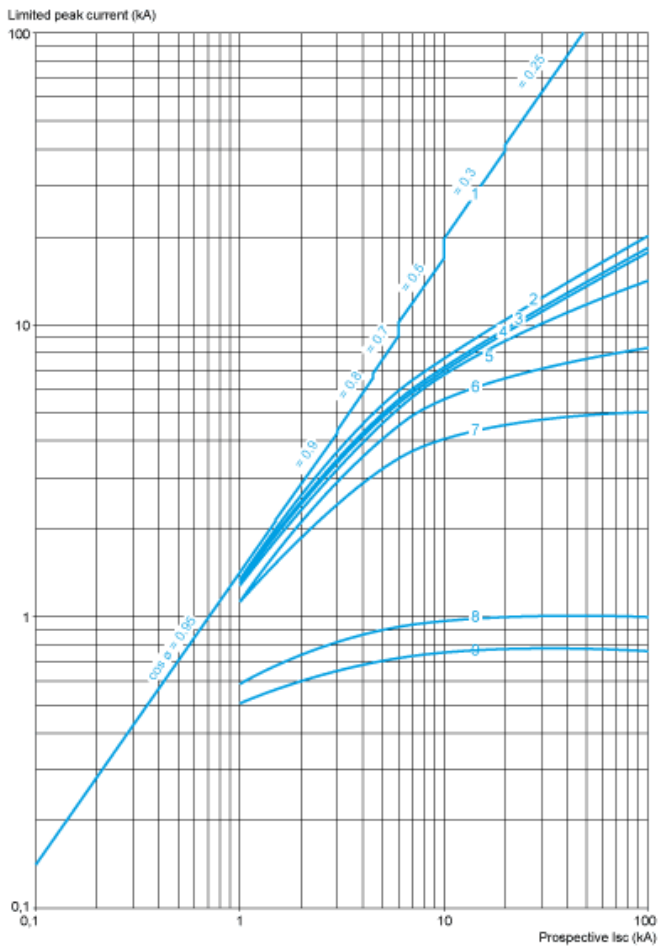

- 1 Maximum peak current
- 2 GV4L115 + LR9D5367 or LR9F5367
- 3 GV4L80 + LRD3361
- 4 GV4L50 + LRD340
- 5 GV4L25 + LRD325
- 6 GV4L12 + LRD313
- 7 GV4L07 + LRD12
- 8 GV4L03 + LRD07
- 9 GV4L02 + LRD07

Thermal Limit on Short-Circuit for GV4L, GV4LE

Thermal Limit in A^2s

Sum of $I^2dt = f(\text{prospective } I_{sc}) \text{ at } 1.05 U_e = 435 \text{ V}$

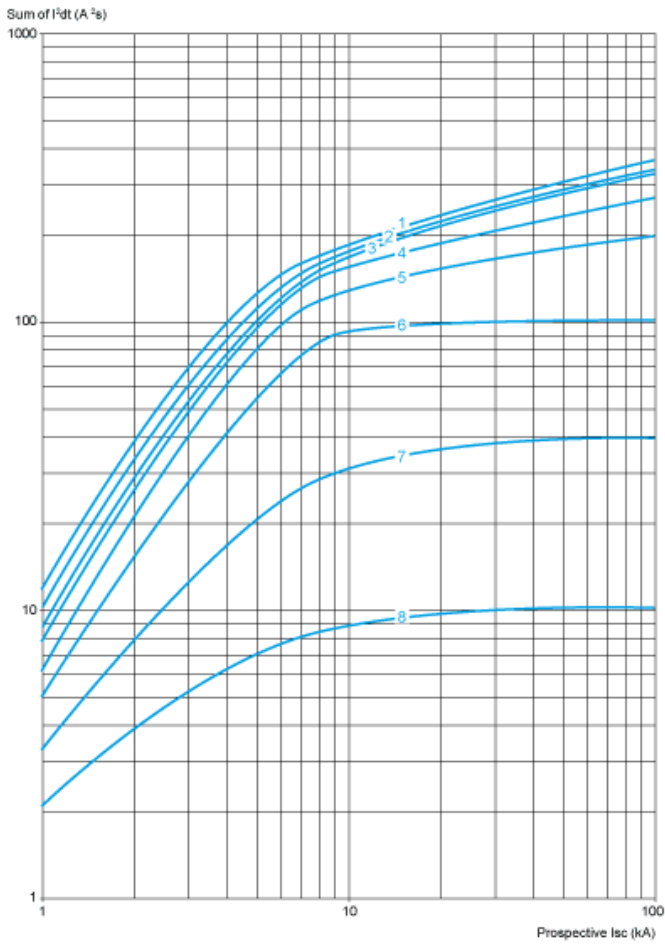

- 1 GV4L115
- 2 GV4L80
- 3 GV4L50
- 4 GV4L25
- 5 GV4L12
- 6 GV4L07
- 7 GV4L03
- 8 GV4L02

Current Limitation on Short-Circuit for GV4L, GV4LE + Thermal Overload Relay LRD or LR9

Thermal Limit in kA in the Magnetic Operating Zone

Sum of $I^2dt = f$ (prospective Isc) at $1.05 U_e = 435 V$

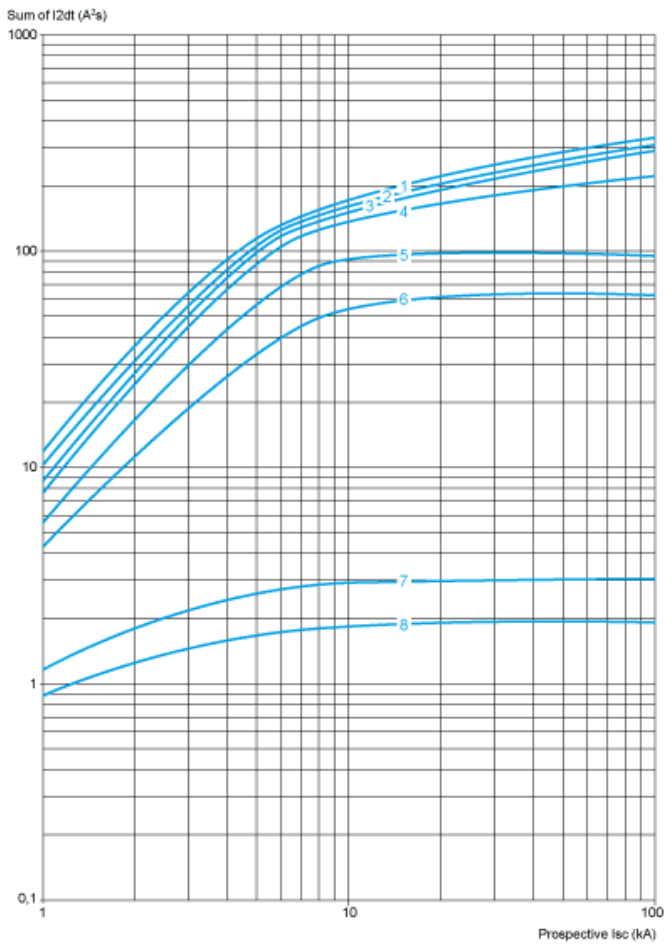

- 1 GV4L115 + LR9D5367 or LR9F5367
- 2 GV4L80 + LRD3361
- 3 GV4L50 + LRD340
- 4 GV4L25 + LRD325
- 5 GV4L12 + LRD313
- 6 GV4L07+ LRD12
- 7 GV4L03+ LRD07
- 8 GV4L02 + LRD07

GV4 with Toggle: GV4LE, GV4PE, GV4PEM

With EverLink® Connector

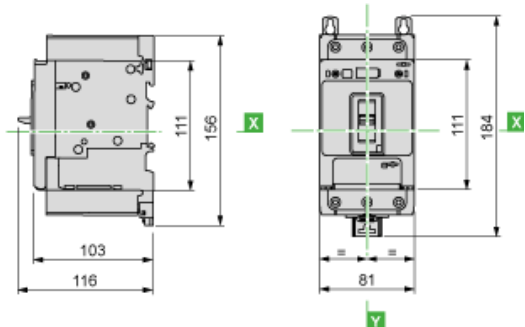

With Crimp Lug Connector

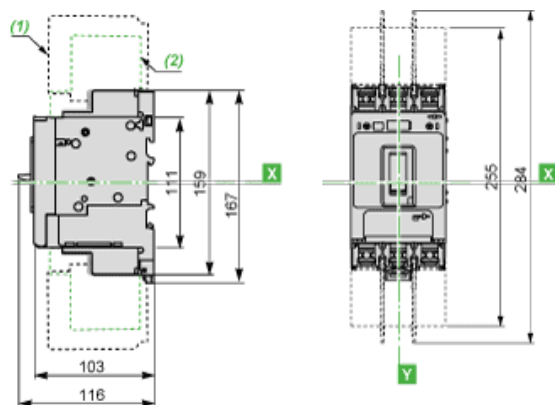

- (1) Interphase barriers
- (2) Long terminal shield

GV4 with Rotary Handle: GV4L, GV4P, or GV4LE, GV4PE, GV4PEM with GV4ADN01, GV4ADN02 Direct Mounting Rotary Handle

Dimensions

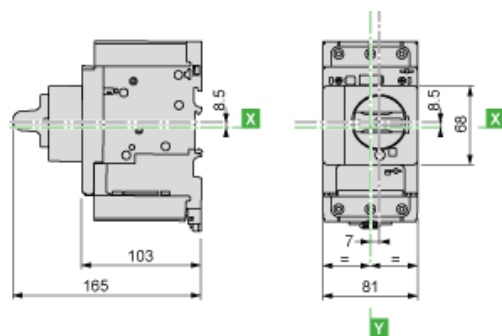

GV4L, GV4P, GV4LE, GV4PE, GV4PEM

Panel Mounting with M4 Screws

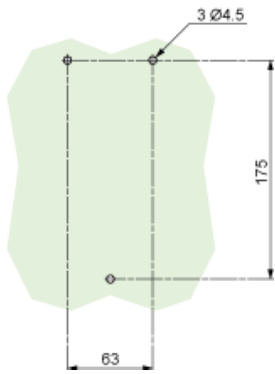

Door Cut-Out for Rotary Handle

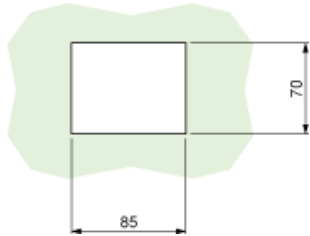

Minimum Safety Clearance

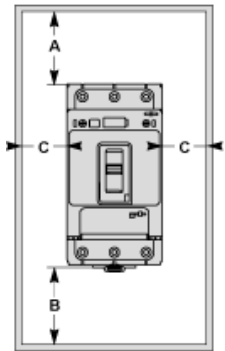

Toggle-type, rotary handle-type: identical clearance values.

| Safety Clearance (mm) | | | | | | |
|-----------------------|---------------------|---|---|------------------|---|---|
| | Painted Sheet Metal | | | Bare Sheet Metal | | |
| | A | B | C | A | B | C |
| No accessory | 30 | 0 | 0 | 40 | 0 | 5 |
| Interphase barriers | 0 | 0 | 0 | 0 | 0 | 5 |
| Long terminal shield | 0 | 0 | 0 | 0 | 0 | 5 |

Magnetic Motor Circuit Breakers

GV4L, GV4LE

